

*Luxe Series*

---

**RAINIER**



**AMERICAN LEATHER**

**Standard Features:**

- Advanced unidirectional suspension system
- Premium high-density, high-resiliency foam seat cushions
- Down blend encased cushioning
- Semi-attached back cushions
- Tight seat cushion
- Double-needle quilting and single-needle top-stitch with thick thread
- Manual articulating headrest
- Manual push-back recline in all seats
- Limited lifetime warranty on frame and suspension
- Three-year warranty on mechanism
- Quick-ship delivery

**Options:**

- Wood legs available in Dune, Ebony, Mink or Oiled Ash finish
- Contrasting stitch detail available in Black, Brown, Charcoal, Cream, Espresso, Grey, Lemon, Pink, Royal, Scarlet, Tangerine, or Teal thread color

**Additional Power Options:**

- Motorized recliner with an in-arm control panel that is easy to use and includes a USB charging port
- Available on seats with an arm (Right and left arms on SO3, both seats on LVS, and seat on RCH)
- SO3 middle seat has Power, Manual, or Stationary options
- Motor has a three-year warranty
- Lithium-ion battery pack available
- Battery pack has a one-year warranty

Please use actual leather, fabric, Crypton®, Sunbrella® and Ultrasuede® swatches when specifying furniture as the colors shown may vary due to the printing process.

**Wall Clearance is 16"**

**Leg height is 2"**

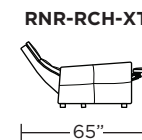
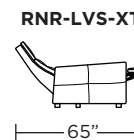
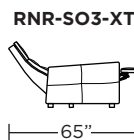
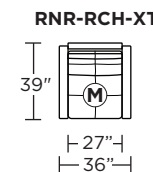
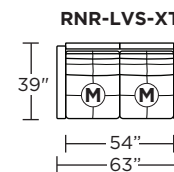
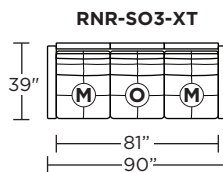
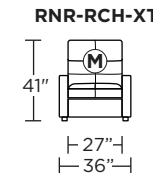
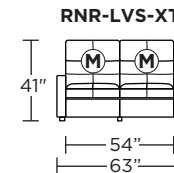
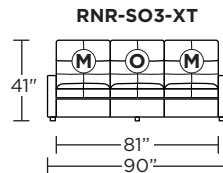
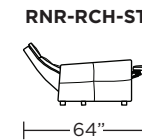
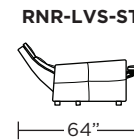
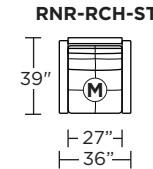
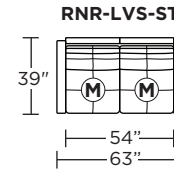
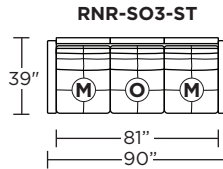
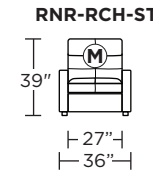
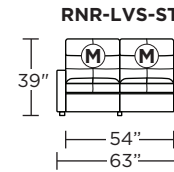
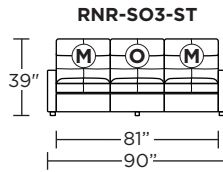
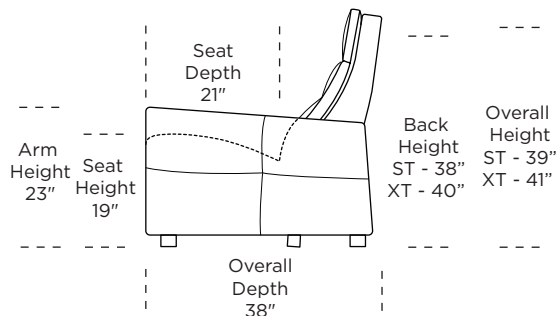

**MOTION LEGEND:**

- M = Motion\* only
- O = Optional motion\* or stationary

\*Manual and Power motion available

Scale: 1/8 inch = 1 foot  
All dimensions are approximate and subject to change.  
Specify components from the sitting position.