

SOFAS & SECTIONALS BY AMERICAN LEATHER®

---

**MANHATTAN**



**AMERICAN  
LEATHER®**

## MANHATTAN

### Standard Features:

- Advanced unidirectional suspension system
- Premium high-density, high-resiliency foam seat cushions
- Loose back and seat cushions
- Double-needle top-stitch
- Recessed welt detail
- Limited lifetime warranty on frame and suspension
- Quick-ship delivery

### Options:

- Contrasting welt detail available
- Contrasting stitch detail available in Black, Brown, Charcoal, Cream, Espresso, Grey, Lemon, Pink, Royal, Scarlet, Tangerine, or Teal thread color
- Aluminum legs available in Gloss Black, Gloss Bronze or Polished Nickel finish

*Please use actual leather, fabric, Crypton®, Sunbrella® and Ultrasuede® swatches when specifying furniture as the colors shown may vary due to the printing process.*

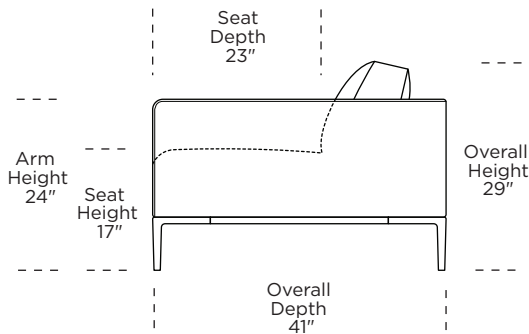
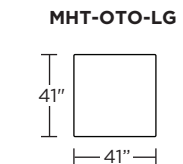
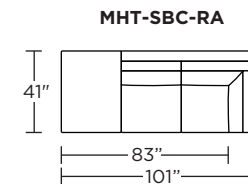
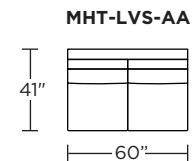
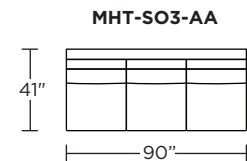
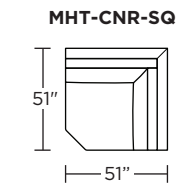
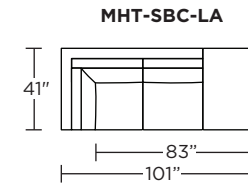
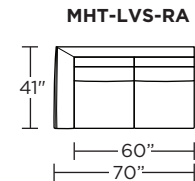
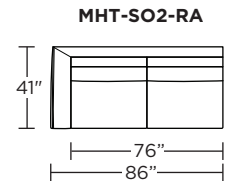
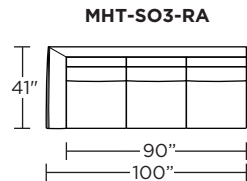
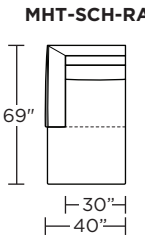
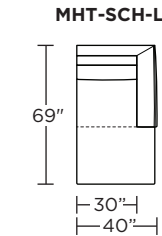
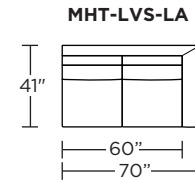
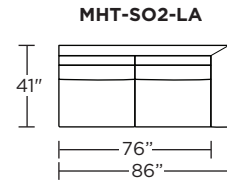
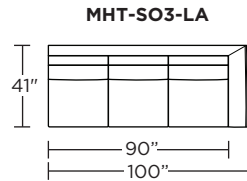
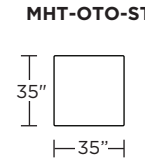
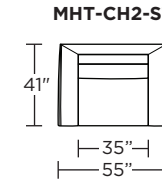
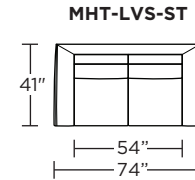
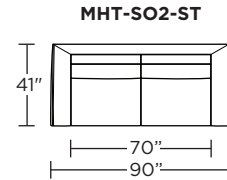
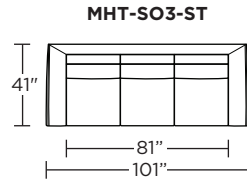
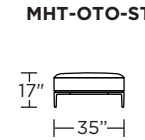
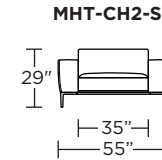
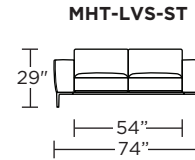
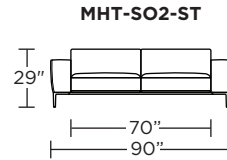
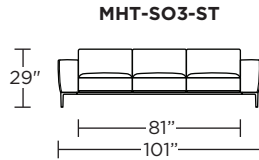

**Note:** Dotted line indicates seam on leather, Ultrasuede® and up the roll fabrics. Seams are eliminated with railroaded fabrics.

Scale: 1/8 inch = 1 foot  
All dimensions are approximate and subject to change.  
Specify components from the sitting position.

V10.02.23